

LME49710 High-Performance, High-Fidelity Audio Operational Amplifier

Check for Samples: [LME49710](#)

FEATURES

- Easily Drives 600Ω Loads
- Optimized for Superior Audio Signal Fidelity
- Output Short Circuit Protection
- PSRR and CMRR Exceed 120dB (Typ)
- SOIC, PDIP, and TO-99 Packages

APPLICATIONS

- Ultra High-Quality Audio Amplification
- High-Fidelity Preamplifiers
- High-Fidelity Multimedia
- State-of-the-Art Phono Pre Amps
- High-Performance Professional Audio
- High-Fidelity Equalization and Crossover Networks
- High-Performance Line Drivers
- High-Performance Line Receivers
- High-Fidelity Active Filters

KEY SPECIFICATIONS

- Power Supply Voltage Range: $\pm 2.5V$ to $\pm 17V$
- THD+N ($A_V = 1$, $V_{OUT} = 3V_{RMS}$, $f_{IN} = 1kHz$)
 - $R_L = 2k\Omega$: 0.00003% (typ)
 - $R_L = 600\Omega$: 0.00003% (typ)
- Input Noise Density: $2.5nV/\sqrt{Hz}$ (typ)
- Slew Rate: $\pm 20V/\mu s$ (typ)
- Gain Bandwidth Product: 55MHz (typ)
- Open Loop Gain ($R_L = 600\Omega$): 140dB (typ)
- Input Bias Current: 7nA (typ)
- Input Offset Voltage: 0.05mV (typ)
- DC Gain Linearity Error: 0.000009%

DESCRIPTION

The LME49710 is part of the ultra-low distortion, low-noise, high-slew-rate operational amplifier series optimized and fully specified for high-performance, high-fidelity applications. Combining advanced leading-edge process technology with state-of-the-art circuit design, the LME49710 audio operational amplifiers deliver superior audio signal amplification for outstanding audio performance. The LME49710 combines extremely low-voltage noise density (2.5nV/Hz) with vanishingly low THD+N (0.00003%) to easily satisfy the most demanding audio applications. To ensure that the most challenging loads are driven without compromise, the LME49710 has a high slew rate of $\pm 20V/\mu s$ and an output current capability of $\pm 26mA$. Further, dynamic range is maximized by an output stage that drives 2kΩ loads to within 1V of either power supply voltage and to within 1.4V when driving 600Ω loads.

The LME49710's outstanding CMRR (120dB), PSRR (120dB), and V_{OS} (0.05mV) give the amplifier excellent operational amplifier DC performance.

The LME49710 has a wide supply range of $\pm 2.5V$ to $\pm 17V$. Over this supply range the LME49710's input circuitry maintains excellent common-mode and power supply rejection, as well as maintaining its low-input bias current. The LME49710 is unity gain stable. The Audio Operational Amplifier achieves outstanding AC performance while driving complex loads with values as high as 100pF.

The LME49710 is available in an 8-lead narrow body SOIC, an 8-lead PDIP, and an 8-lead TO-99. Demonstration boards are available for each package.



Please be aware that an important notice concerning availability, standard warranty, and use in critical applications of Texas Instruments semiconductor products and disclaimers thereto appears at the end of this data sheet.

All trademarks are the property of their respective owners.

TYPICAL APPLICATION

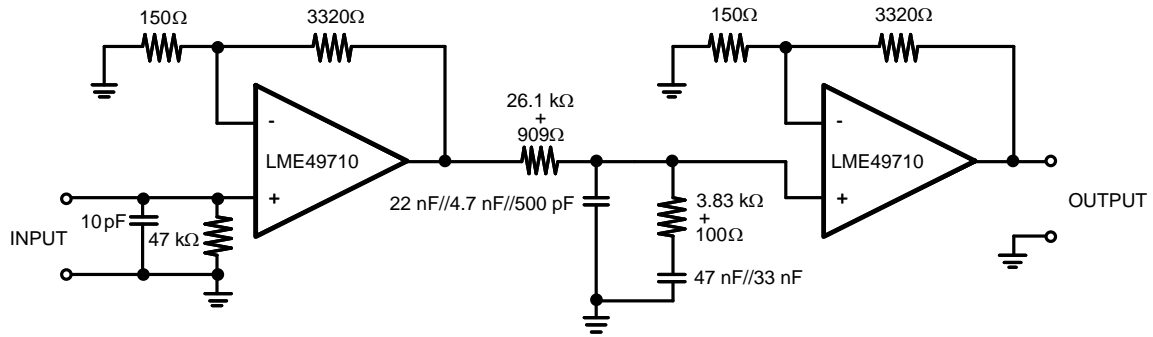

Note: 1% metal film resistors, 5% polypropylene capacitors

Figure 1. Passively Equalized RIAA Phono Preamp

CONNECTION DIAGRAMS

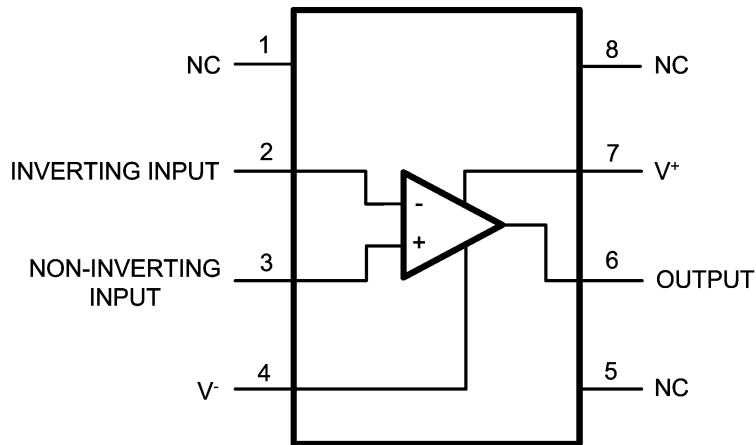

**Figure 2. 8-Lead SOIC (D Package)
8-Lead PDIP (P Package)**

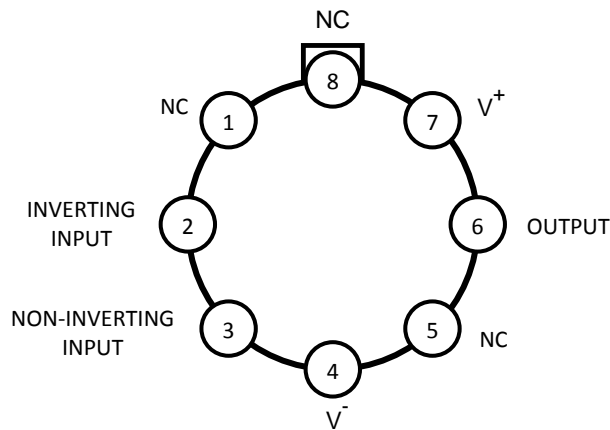

Figure 3. 8-Lead TO-99 (LMC Package)



These devices have limited built-in ESD protection. The leads should be shorted together or the device placed in conductive foam during storage or handling to prevent electrostatic damage to the MOS gates.

ABSOLUTE MAXIMUM RATINGS⁽¹⁾⁽²⁾⁽³⁾

Power Supply Voltage ($V_S = V^+ - V^-$)		36V
Storage Temperature		-65°C to 150°C
Input Voltage		(V-) - 0.7V to (V+) + 0.7V
Output Short Circuit ⁽⁴⁾		Continuous
Power Dissipation		Internally Limited
ESD Susceptibility ⁽⁵⁾		2000V
ESD Susceptibility ⁽⁶⁾		200V
Junction Temperature		150°C
Thermal Resistance	θ_{JA} (D)	145°C/W
	θ_{JA} (P)	102°C/W
	θ_{JA} (LMC)	150°C/W
	θ_{JC} (LMC)	35°C/W
Temperature Range ($T_{MIN} \leq T_A \leq T_{MAX}$)		-40°C $\leq T_A \leq$ 85°C
Supply Voltage Range		$\pm 2.5V \leq V_S \leq \pm 17V$

- (1) *Absolute Maximum Ratings* indicate limits beyond which damage to the device may occur.
- (2) Operating Ratings indicate conditions for which the device is functional, but do not ensure specific performance limits. For ensured specifications and test conditions, see the Electrical Characteristics. The ensured specifications apply only for the test conditions listed. Some performance characteristics may degrade when the device is not operated under the listed test conditions.
- (3) If Military/Aerospace specified devices are required, please contact the Texas Instruments Sales Office/Distributors for availability and specifications.
- (4) Amplifier output connected to GND, any number of amplifiers within a package.
- (5) Human body model, 100pF discharged through a 1.5k Ω resistor.
- (6) Machine Model ESD test is covered by specification EIAJ IC-121-1981. A 200pF cap is charged to the specified voltage and then discharged directly into the IC with no external series resistor (resistance of discharge path must be under 50 Ω).

ELECTRICAL CHARACTERISTICS⁽¹⁾⁽²⁾

The following specifications apply for $V_S = \pm 15V$, $R_L = 2k\Omega$, $f_{IN} = 1kHz$, and $T_A = 25^\circ C$, unless otherwise specified.

Symbol	Parameter	Conditions	LME49710		Units (Limits)
			Typical ⁽³⁾	Limit ⁽⁴⁾⁽⁵⁾	
THD+N	Total Harmonic Distortion + Noise	$A_V = 1$, $V_{OUT} = 3V_{RMS}$ $R_L = 2k\Omega$ $R_L = 600\Omega$	0.00003 0.00003	0.00009	% (max) % (max)
IMD	Intermodulation Distortion	$A_V = 1$, $V_{OUT} = 3V_{RMS}$ Two-tone, 60Hz & 7kHz 4:1	0.00005		% (max)
GBWP	Gain Bandwidth Product		55	45	MHz (min)
SR	Slew Rate		± 20	± 15	V/ μs (min)
FPBW	Full Power Bandwidth	$V_{OUT} = 1V_{P-P}$, -3dB referenced to output magnitude at $f = 1kHz$	10		MHz
t_s	Settling time	$A_V = 1$, 10V step, $C_L = 100pF$ 0.1% error range	1.2		μs
e_n	Equivalent Input Noise Voltage	$f_{BW} = 20Hz$ to 20kHz	0.34	0.65	μV_{RMS}
	Equivalent Input Noise Density	$f = 1kHz$ $f = 10Hz$	2.5 6.4	4.7	nV/\sqrt{Hz} nV/\sqrt{Hz}
i_n	Current Noise Density	$f = 1kHz$	1.6		pA/\sqrt{Hz}
		$f = 10Hz$	3.1		pA/\sqrt{Hz}

- (1) *Absolute Maximum Ratings* indicate limits beyond which damage to the device may occur.
- (2) Operating Ratings indicate conditions for which the device is functional, but do not ensure specific performance limits. For ensured specifications and test conditions, see the Electrical Characteristics. The ensured specifications apply only for the test conditions listed. Some performance characteristics may degrade when the device is not operated under the listed test conditions.
- (3) Typical specifications are specified at +25°C and represent the most likely parametric norm.
- (4) Tested limits are specified to AOQL (Average Outgoing Quality Level).
- (5) Datasheet min/max specification limits are ensured by design, test, or statistical analysis.

ELECTRICAL CHARACTERISTICS⁽¹⁾⁽²⁾ (continued)

The following specifications apply for $V_S = \pm 15V$, $R_L = 2k\Omega$, $f_{IN} = 1kHz$, and $T_A = 25^\circ C$, unless otherwise specified.

Symbol	Parameter	Conditions	LME49710		Units (Limits)
			Typical ⁽³⁾	Limit ⁽⁴⁾⁽⁵⁾	
V_{OS}	Offset Voltage		± 0.05	± 0.7	mV (max)
$\Delta V_{OS}/\Delta Temp$	Average Input Offset Voltage Drift vs Temperature	$40^\circ C \leq T_A \leq 85^\circ C$	0.2		$\mu V/^\circ C$
PSRR	Average Input Offset Voltage Shift vs Power Supply Voltage	$\Delta V_S = 20V^{(6)}$	125	110	dB (min)
I_B	Input Bias Current	$V_{CM} = 0V$	7	72	nA (max)
$\Delta I_{OS}/\Delta Temp$	Input Bias Current Drift vs Temperature	$-40^\circ C \leq T_A \leq 85^\circ C$	0.1		nA/°C
I_{OS}	Input Offset Current	$V_{CM} = 0V$	5	65	nA (max)
V_{IN-CM}	Common-Mode Input Voltage Range		+14.1 -13.9	(V+) – 2.0 (V-) + 2.0	V (min) V (min)
CMRR	Common-Mode Rejection	$-10V < V_{CM} < 10V$	120	110	dB (min)
Z_{IN}	Differential Input Impedance		30		k Ω
	Common Mode Input Impedance	$-10V < V_{CM} < 10V$	1000		M Ω
A_{VOL}	Open Loop Voltage Gain	$-10V < V_{OUT} < 10V$, $R_L = 600\Omega$	140		dB
		$-10V < V_{OUT} < 10V$, $R_L = 2k\Omega$	140	125	dB
		$-10V < V_{OUT} < 10V$, $R_L = 10k\Omega$	140		dB
V_{OUTMAX}	Maximum Output Voltage Swing	$R_L = 600\Omega$	± 13.6	± 12.5	V
		$R_L = 2k\Omega$	± 14.0		V
		$R_L = 10k\Omega$	± 14.1		V
I_{OUT}	Output Current	$R_L = 600\Omega$, $V_S = \pm 17V$	± 26	± 23	mA (min)
I_{OUT-CC}	Short Circuit Current		+53 -42		mA mA
R_{OUT}	Output Impedance	$f_{IN} = 10kHz$ Closed-Loop	0.01		Ω
		Open-Loop	13		Ω
C_{LOAD}	Capacitive Load Drive Overshoot	100pF	16		%
I_S	Quiescent Current	$I_{OUT} = 0mA$	4.8	5.5	mA (max)

(6) PSRR is measured as follows: V_{OS} is measured at two supply voltages, $\pm 5V$ and $\pm 15V$. $PSRR = |20\log(\Delta V_{OS}/\Delta V_S)|$.

TYPICAL PERFORMANCE CHARACTERISTICS

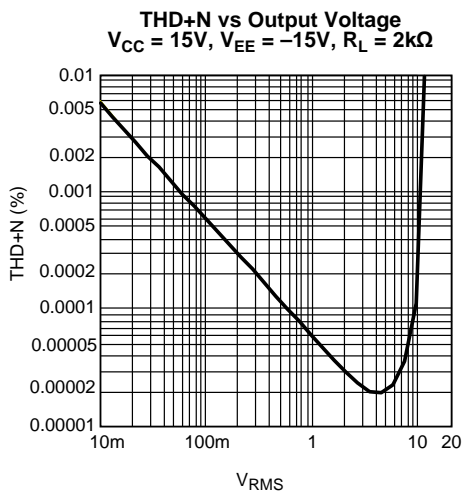

Figure 4.

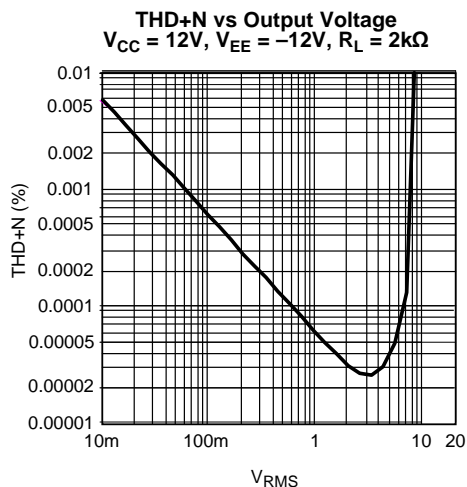

Figure 5.

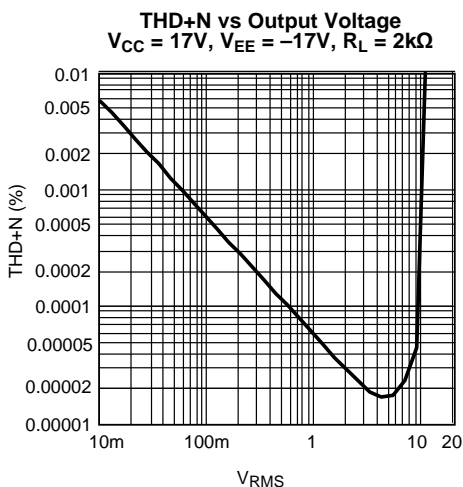

Figure 6.

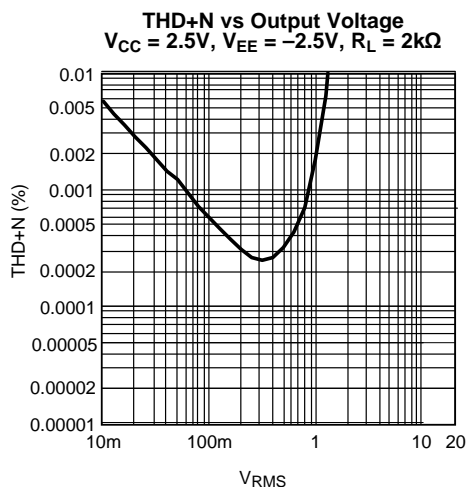

Figure 7.

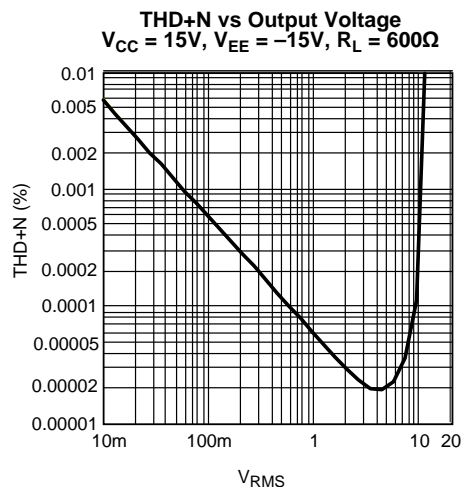

Figure 8.

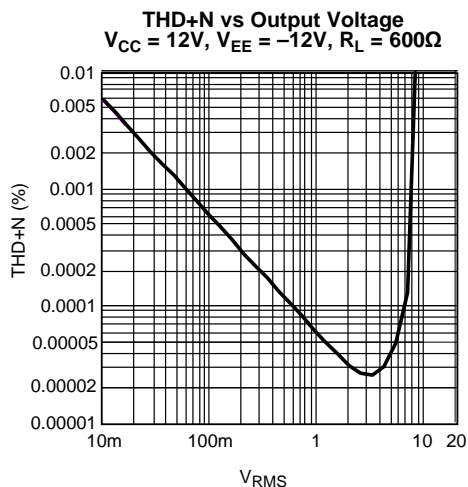

Figure 9.

TYPICAL PERFORMANCE CHARACTERISTICS (continued)

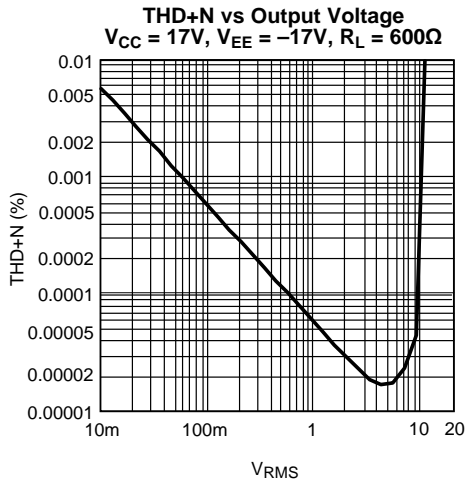

Figure 10.

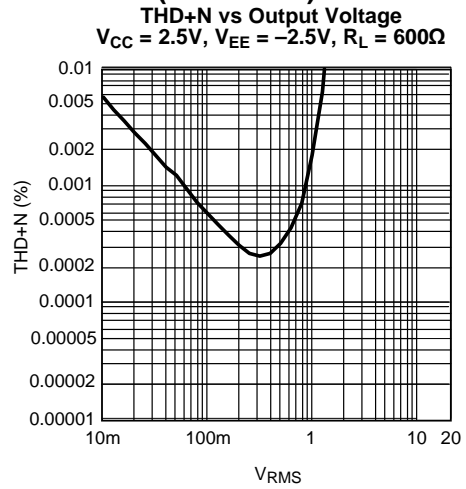

Figure 11.

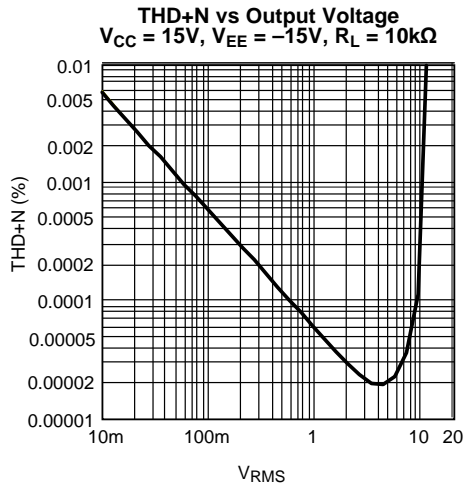

Figure 12.

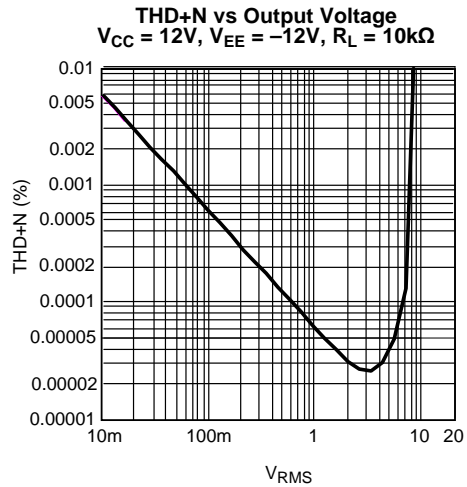

Figure 13.

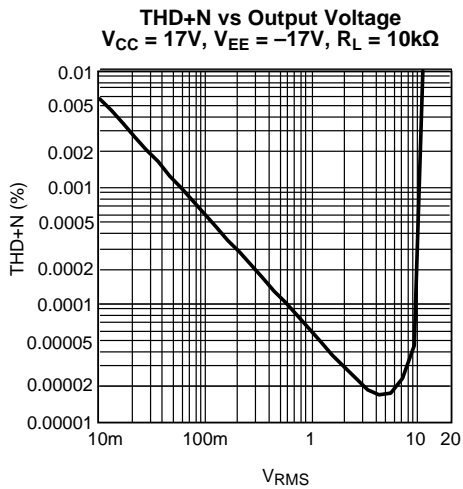

Figure 14.

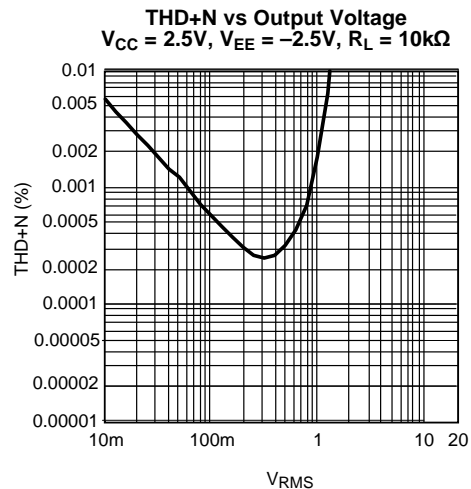

Figure 15.

TYPICAL PERFORMANCE CHARACTERISTICS (continued)

THD+N vs Frequency
 $V_{CC} = 15V, V_{EE} = -15V,$
 $R_L = 2k\Omega, V_{OUT} = 3V_{RMS}$

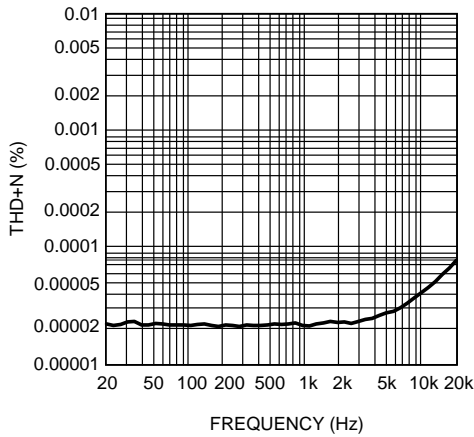

Figure 16.

THD+N vs Frequency
 $V_{CC} = 17V, V_{EE} = -17V,$
 $R_L = 2k\Omega, V_{OUT} = 3V_{RMS}$

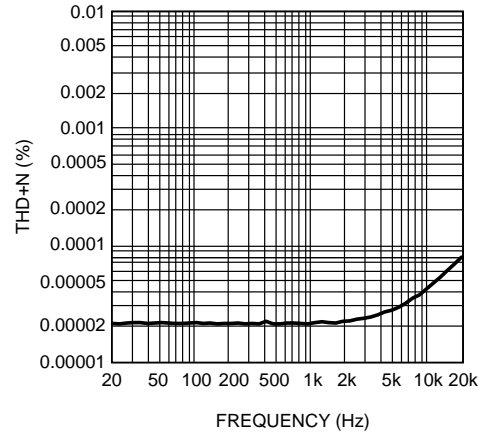

Figure 17.

THD+N vs Frequency
 $V_{CC} = 15V, V_{EE} = -15V,$
 $R_L = 600\Omega, V_{OUT} = 3V_{RMS}$

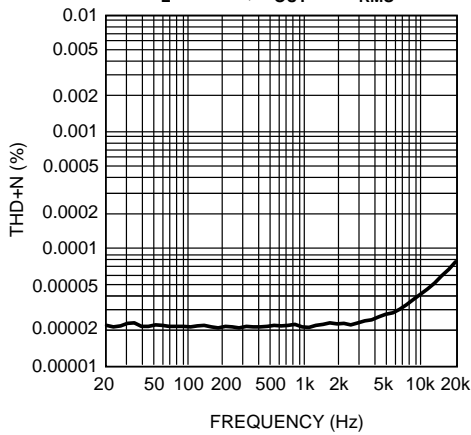

Figure 18.

THD+N vs Frequency
 $V_{CC} = 17V, V_{EE} = -17V,$
 $R_L = 600\Omega, V_{OUT} = 3V_{RMS}$

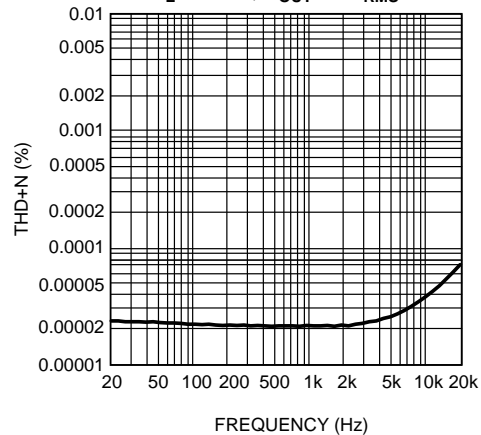

Figure 19.

THD+N vs Frequency
 $V_{CC} = 15V, V_{EE} = -15V,$
 $R_L = 10k\Omega, V_{OUT} = 3V_{RMS}$

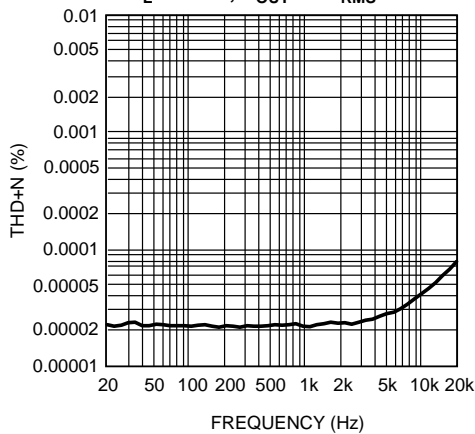

Figure 20.

THD+N vs Frequency
 $V_{CC} = 17V, V_{EE} = -17V,$
 $R_L = 10k\Omega, V_{OUT} = 3V_{RMS}$

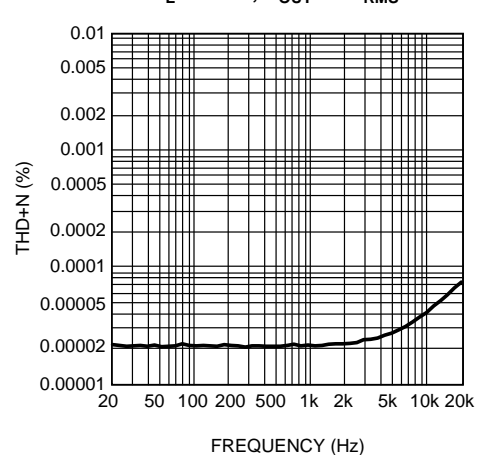

Figure 21.

TYPICAL PERFORMANCE CHARACTERISTICS (continued)

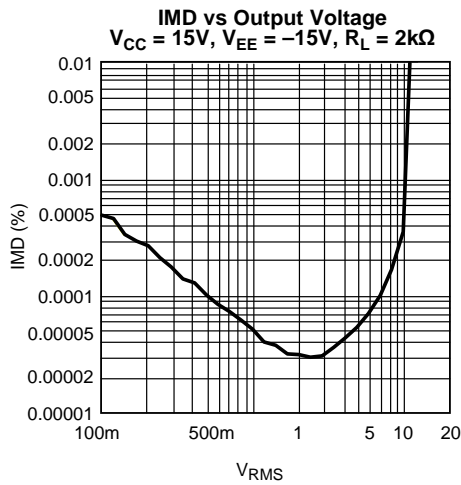

Figure 22.

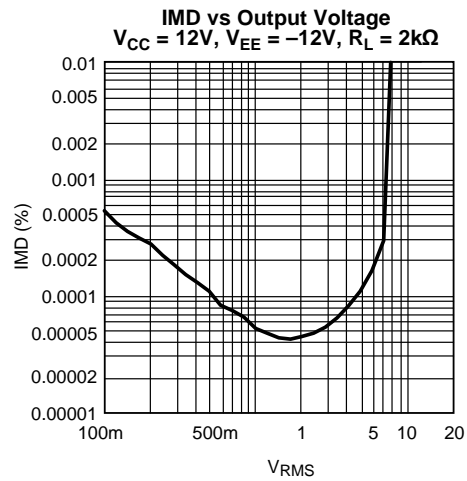

Figure 23.

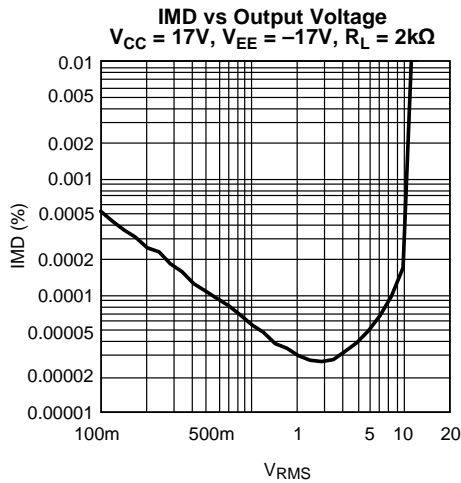

Figure 24.

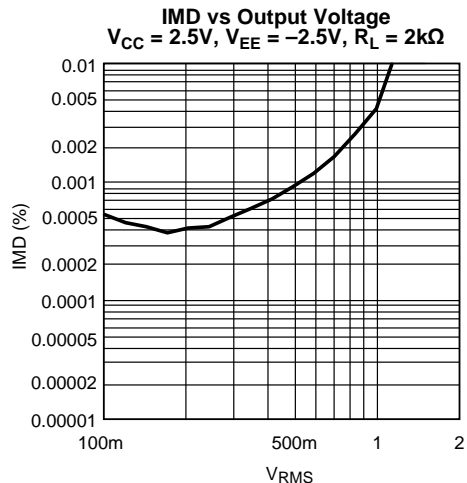

Figure 25.

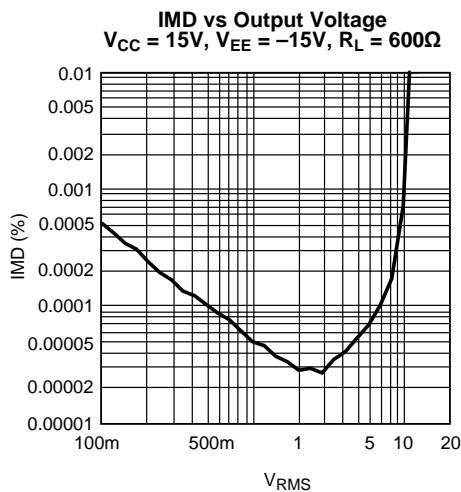

Figure 26.

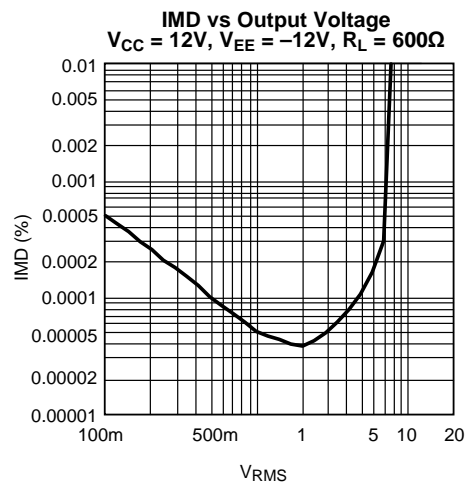

Figure 27.

TYPICAL PERFORMANCE CHARACTERISTICS (continued)

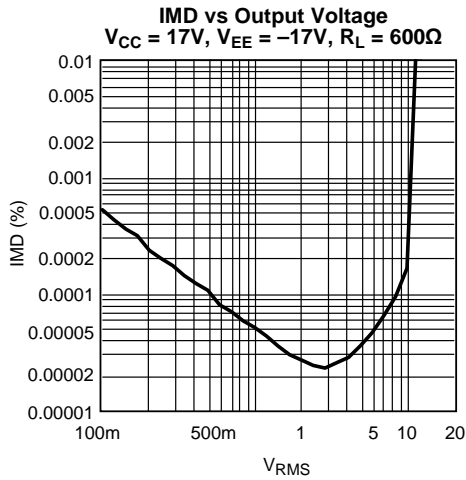

Figure 28.

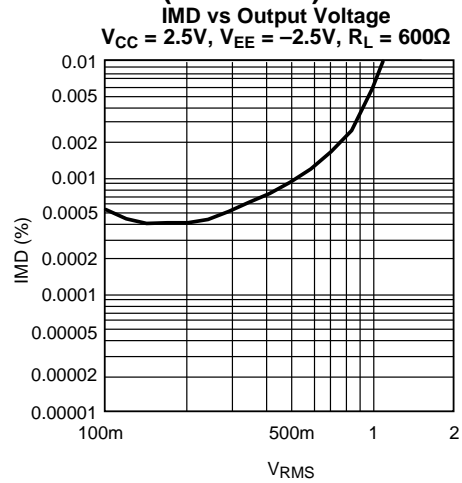

Figure 29.

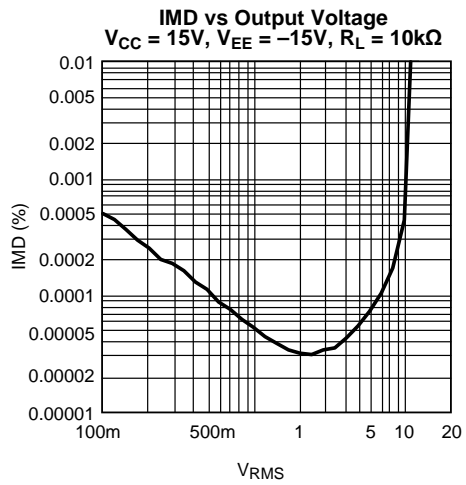

Figure 30.

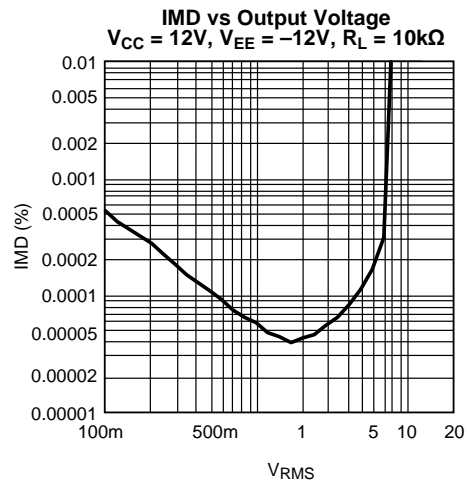

Figure 31.

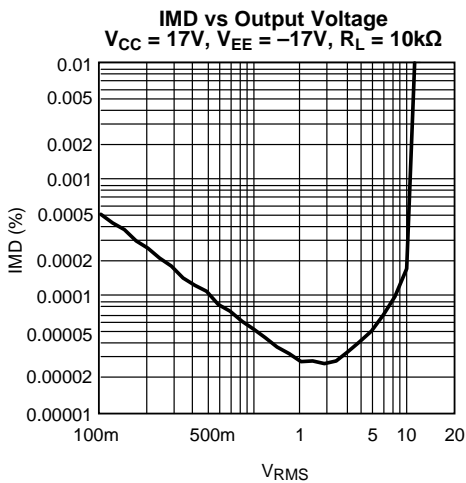

Figure 32.

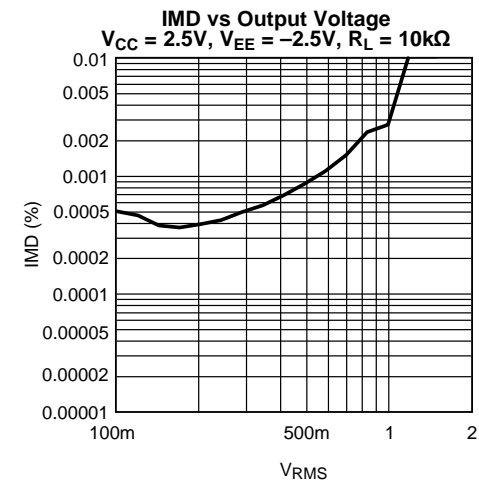

Figure 33.

TYPICAL PERFORMANCE CHARACTERISTICS (continued)

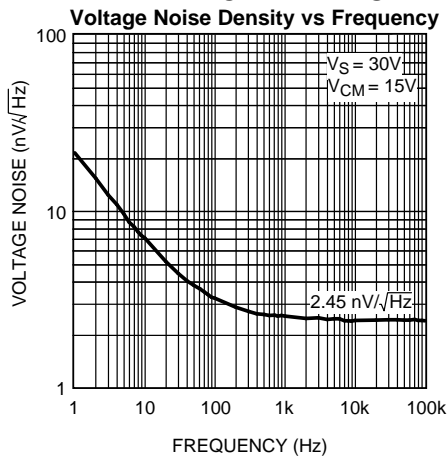

Figure 34.

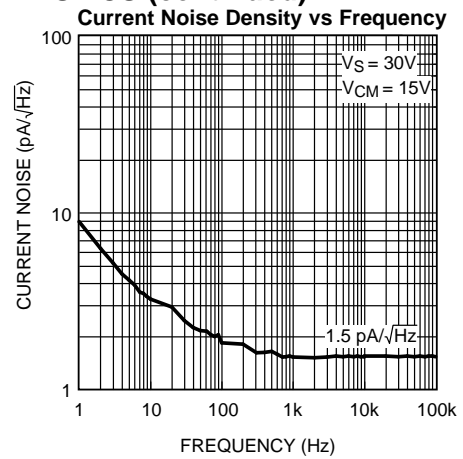

Figure 35.

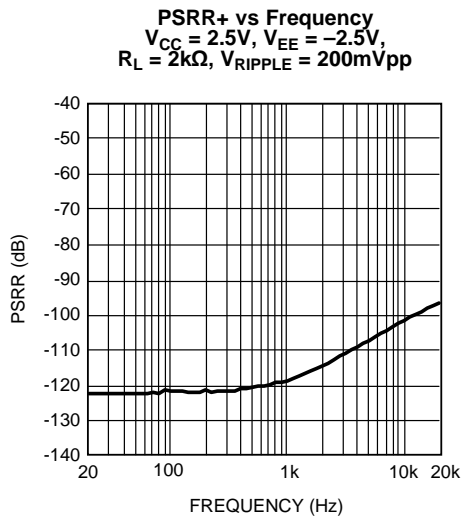

Figure 36.

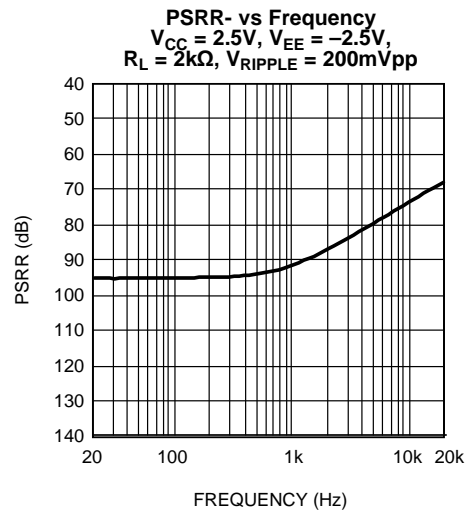

Figure 37.

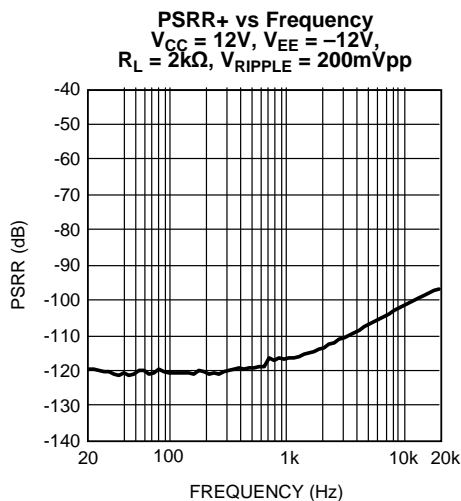

Figure 38.

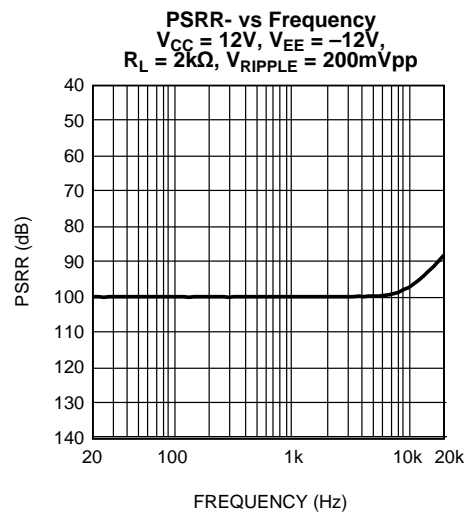

Figure 39.

TYPICAL PERFORMANCE CHARACTERISTICS (continued)

PSRR+ vs Frequency
 $V_{CC} = 15V, V_{EE} = -15V,$
 $R_L = 2k\Omega, V_{RIPPLE} = 200mV_{pp}$

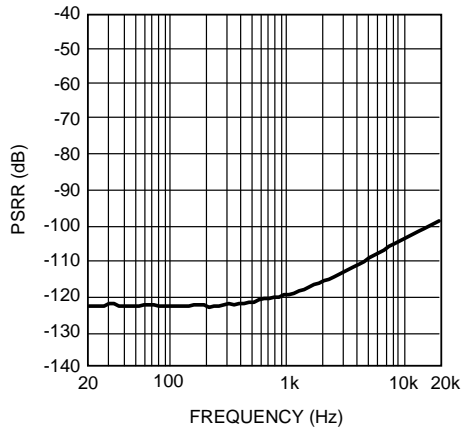

Figure 40.

PSRR- vs Frequency
 $V_{CC} = 15V, V_{EE} = -15V,$
 $R_L = 2k\Omega, V_{RIPPLE} = 200mV_{pp}$

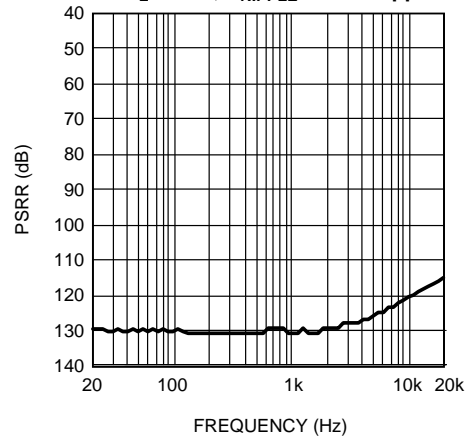

Figure 41.

PSRR+ vs Frequency
 $V_{CC} = 17V, V_{EE} = -17V,$
 $R_L = 2k\Omega, V_{RIPPLE} = 200mV_{pp}$

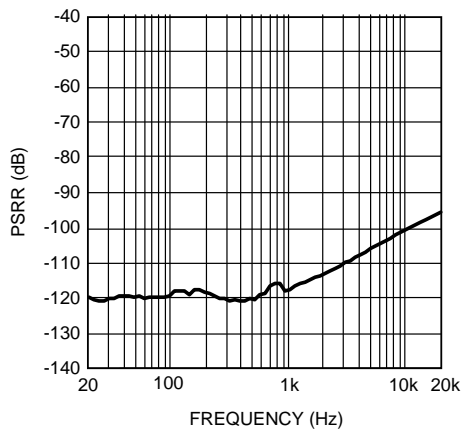

Figure 42.

PSRR- vs Frequency
 $V_{CC} = 17V, V_{EE} = -17V,$
 $R_L = 2k\Omega, V_{RIPPLE} = 200mV_{pp}$

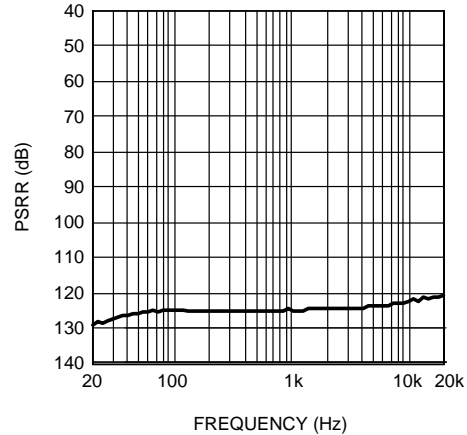

Figure 43.

PSRR+ vs Frequency
 $V_{CC} = 2.5V, V_{EE} = -2.5V,$
 $R_L = 600\Omega, V_{RIPPLE} = 200mV_{pp}$

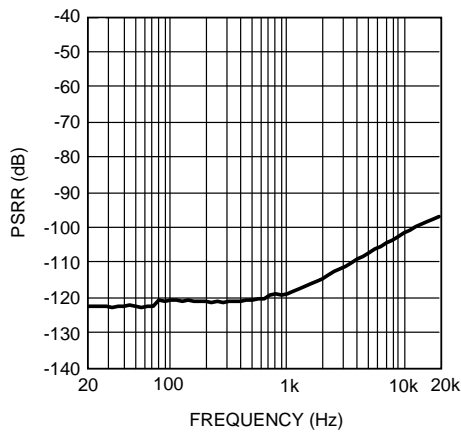

Figure 44.

PSRR- vs Frequency
 $V_{CC} = 2.5V, V_{EE} = -2.5V,$
 $R_L = 600\Omega, V_{RIPPLE} = 200mV_{pp}$

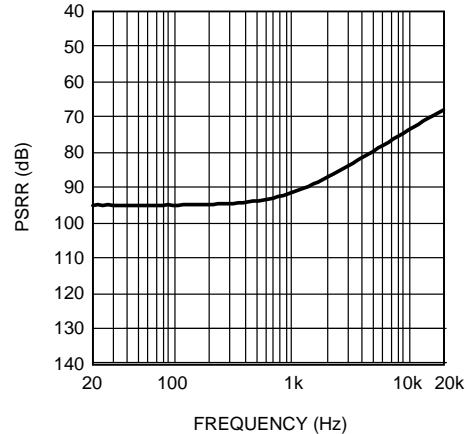

Figure 45.

TYPICAL PERFORMANCE CHARACTERISTICS (continued)

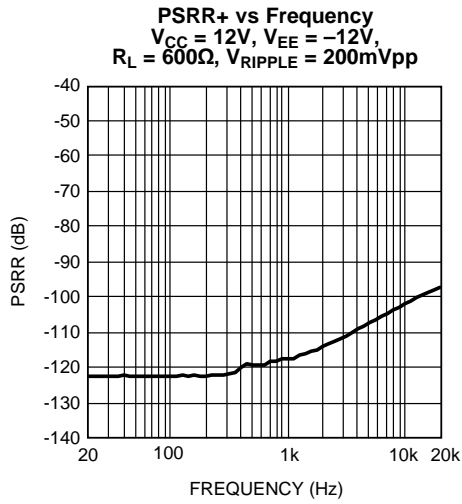

Figure 46.

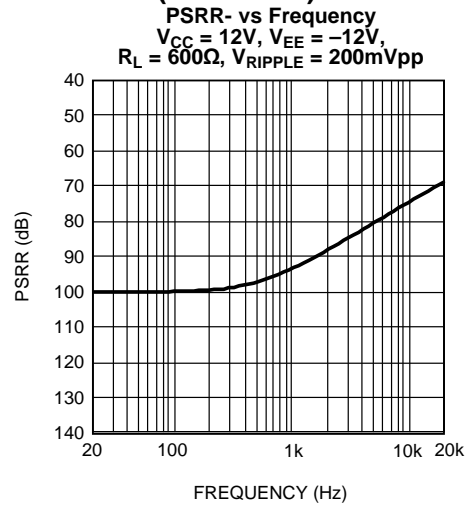

Figure 47.

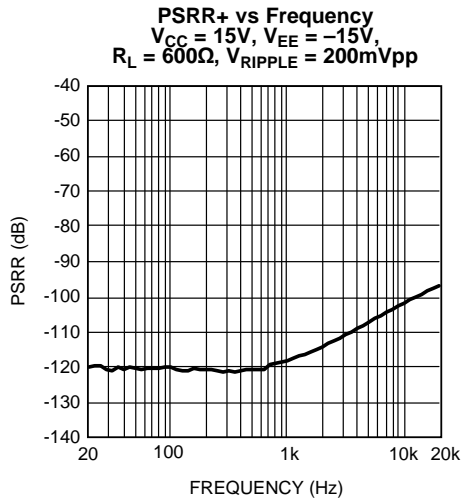

Figure 48.

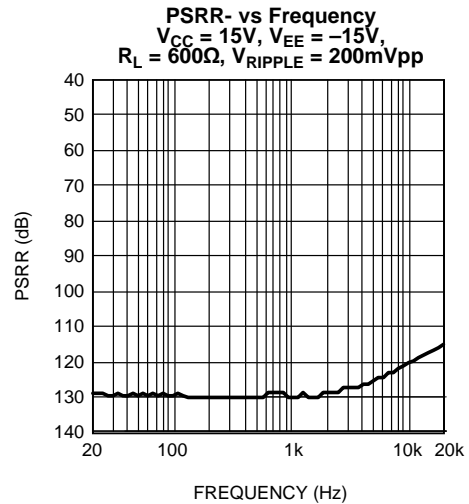

Figure 49.

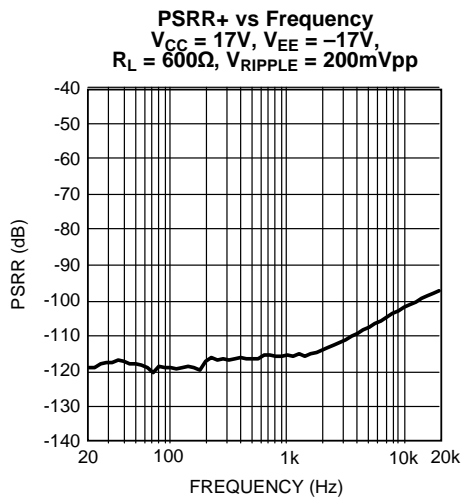

Figure 50.

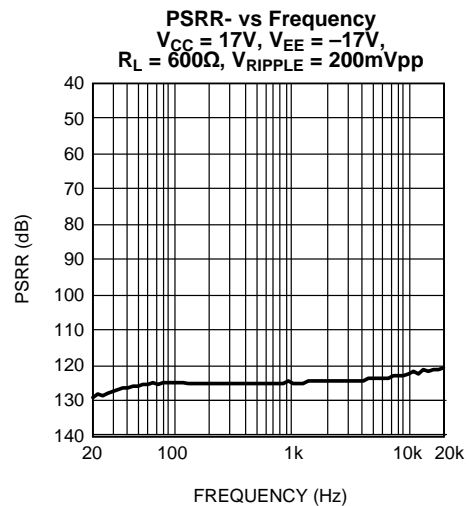

Figure 51.

TYPICAL PERFORMANCE CHARACTERISTICS (continued)

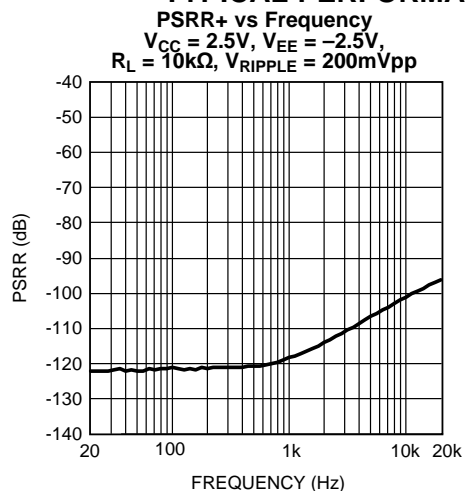

Figure 52.

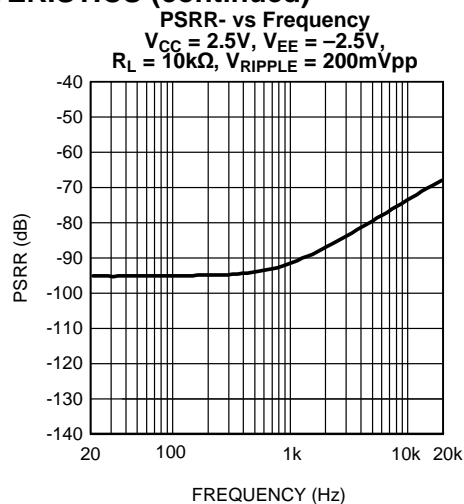

Figure 53.

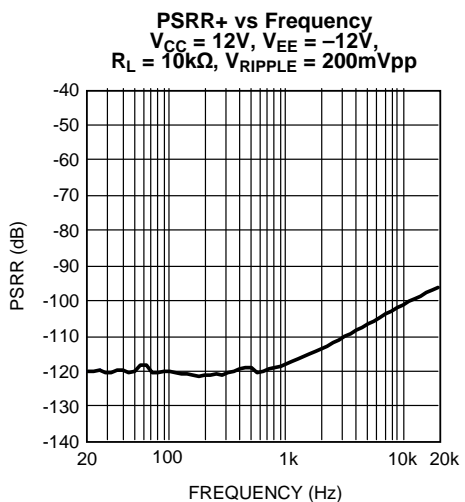

Figure 54.

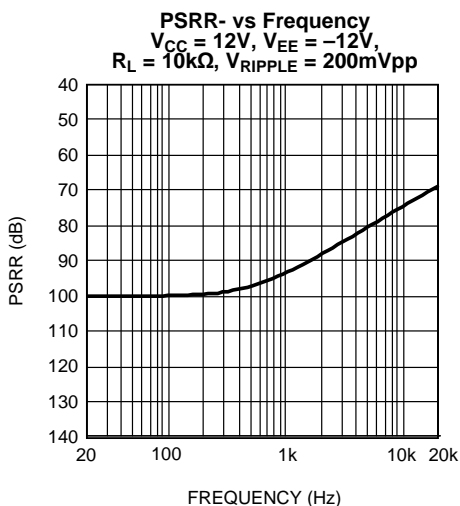

Figure 55.

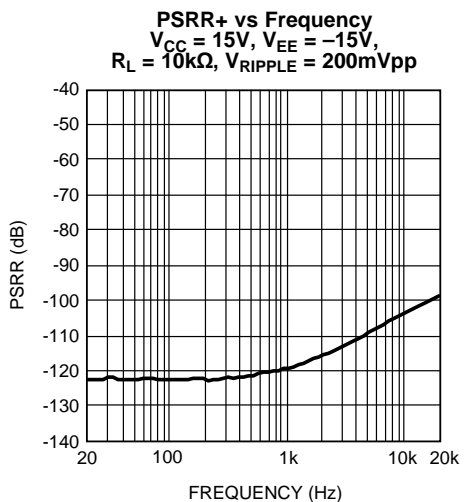

Figure 56.

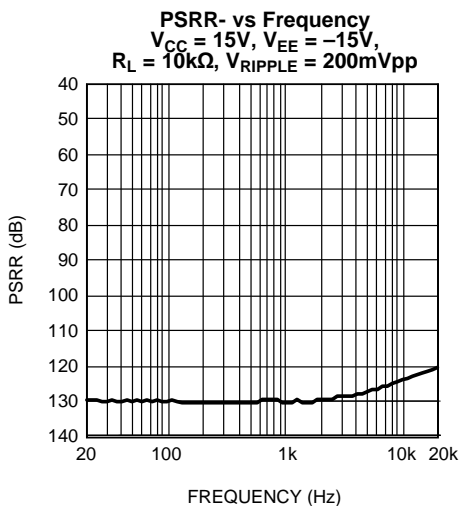

Figure 57.

TYPICAL PERFORMANCE CHARACTERISTICS (continued)

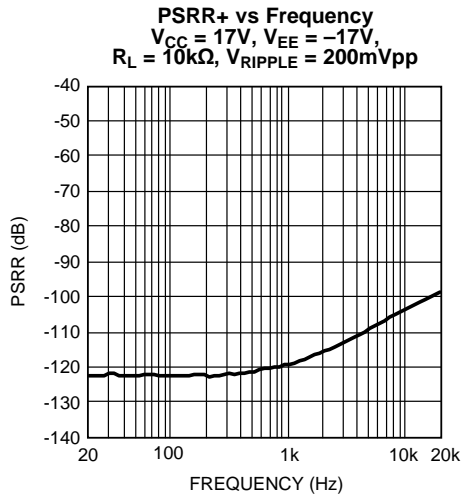

Figure 58.

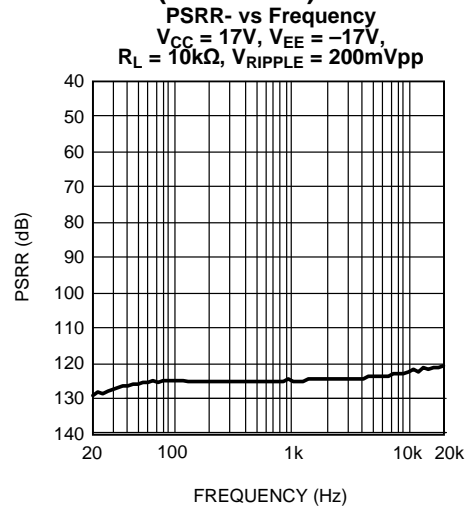

Figure 59.

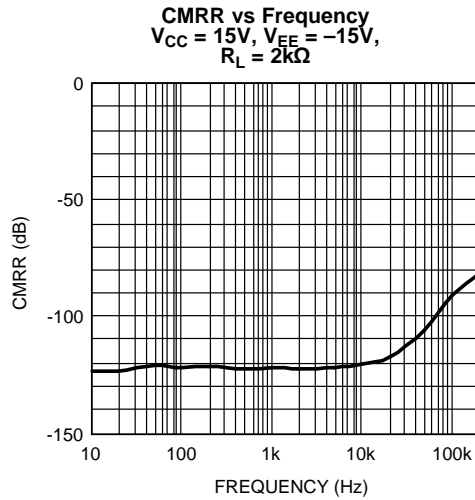

Figure 60.

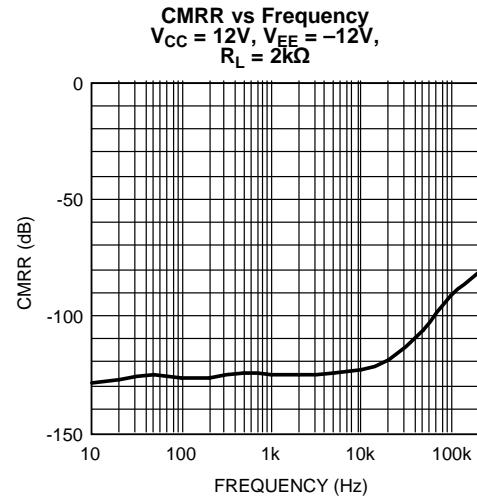

Figure 61.

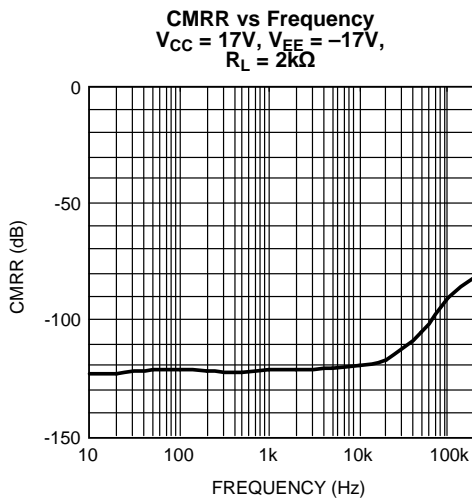

Figure 62.

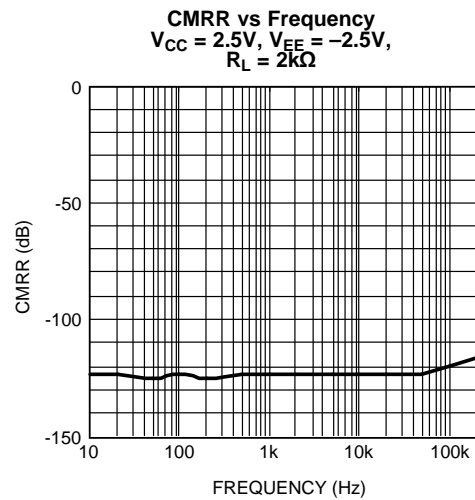

Figure 63.

TYPICAL PERFORMANCE CHARACTERISTICS (continued)

CMRR vs Frequency
 $V_{CC} = 15V, V_{EE} = -15V,$
 $R_L = 600\Omega$

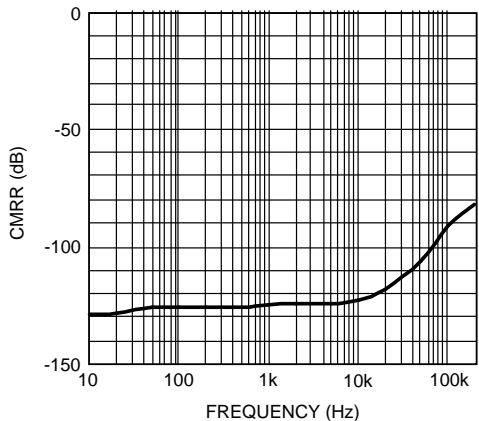

Figure 64.

CMRR vs Frequency
 $V_{CC} = 12V, V_{EE} = -12V,$
 $R_L = 600\Omega$

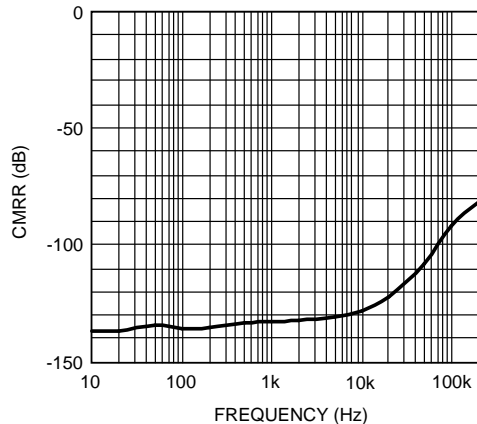

Figure 65.

CMRR vs Frequency
 $V_{CC} = 17V, V_{EE} = -17V,$
 $R_L = 600\Omega$

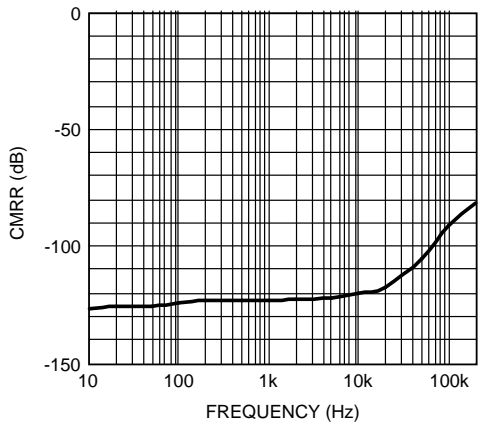

Figure 66.

CMRR vs Frequency
 $V_{CC} = 2.5V, V_{EE} = -2.5V,$
 $R_L = 600\Omega$

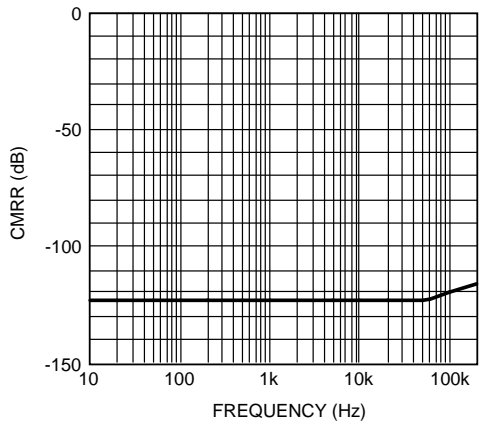

Figure 67.

CMRR vs Frequency
 $V_{CC} = 15V, V_{EE} = -15V,$
 $R_L = 10k\Omega$

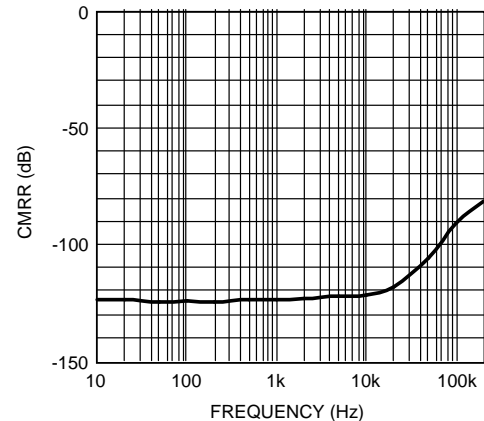

Figure 68.

CMRR vs Frequency
 $V_{CC} = 12V, V_{EE} = -12V,$
 $R_L = 10k\Omega$

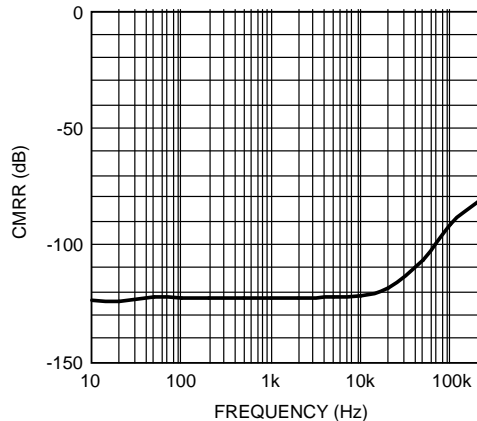

Figure 69.

TYPICAL PERFORMANCE CHARACTERISTICS (continued)

CMRR vs Frequency
 $V_{CC} = 17V, V_{EE} = -17V,$
 $R_L = 10k\Omega$

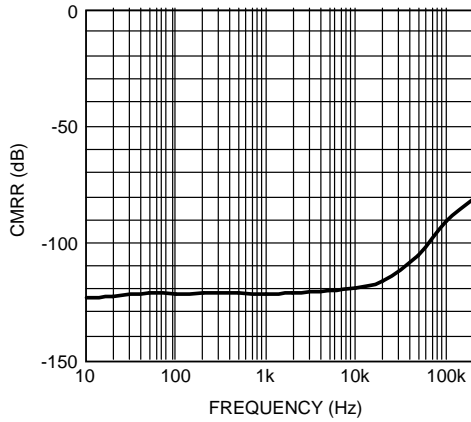

Figure 70.

CMRR vs Frequency
 $V_{CC} = 2.5V, V_{EE} = -2.5V,$
 $R_L = 10k\Omega$

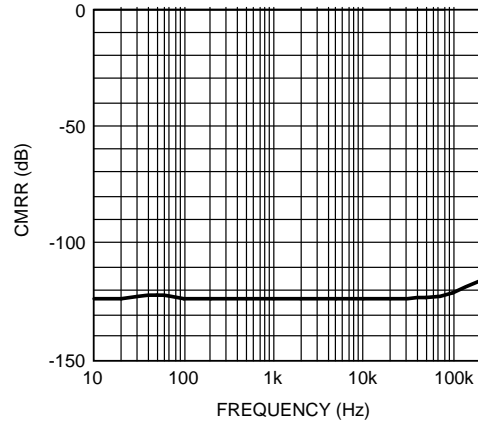

Figure 71.

Output Voltage vs Supply Voltage
 $R_L = 2k\Omega, THD+N = 1\%$

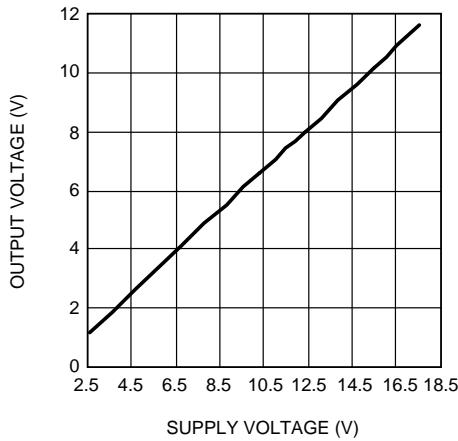

Figure 72.

Output Voltage vs Supply Voltage
 $R_L = 600\Omega, THD+N = 1\%$

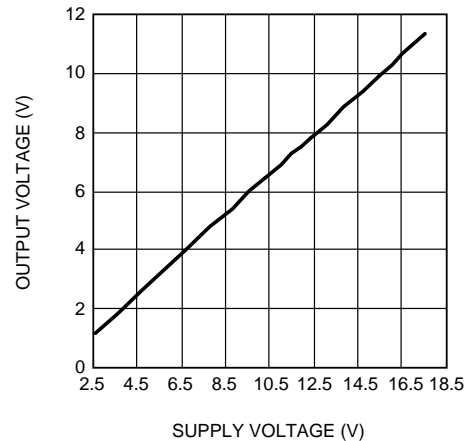

Figure 73.

Output Voltage vs Supply Voltage
 $R_L = 10k\Omega, THD+N = 1\%$

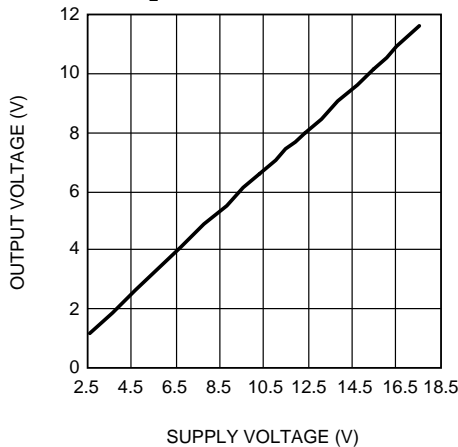

Figure 74.

Output Voltage vs Load Resistance
 $V_{CC} = 15V, V_{EE} = -15V, THD+N = 1\%$

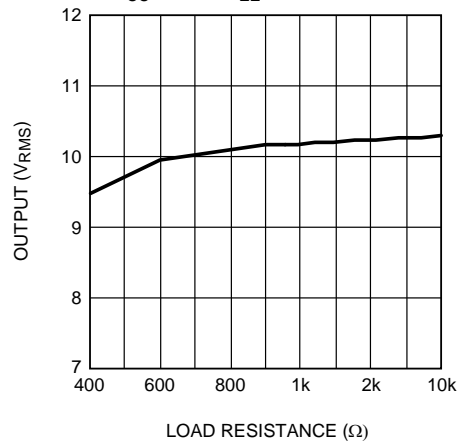

Figure 75.

TYPICAL PERFORMANCE CHARACTERISTICS (continued)

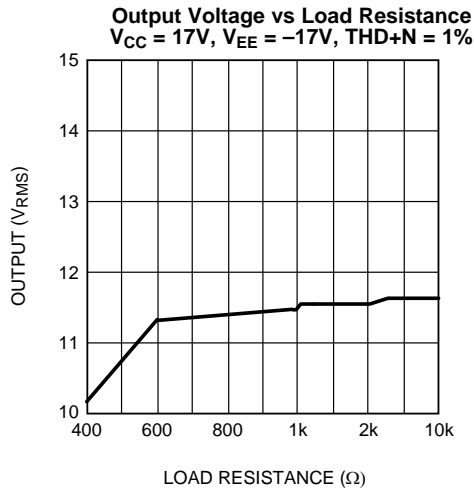

Figure 76.

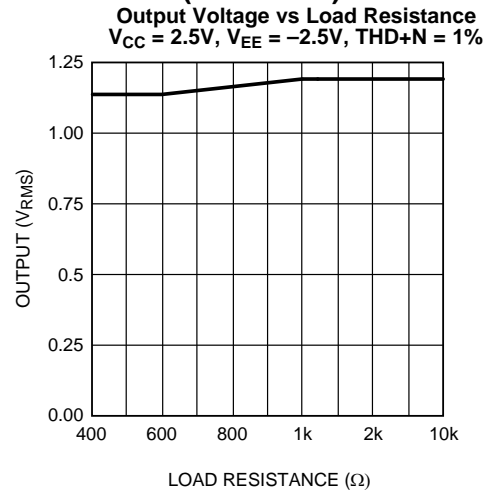

Figure 77.

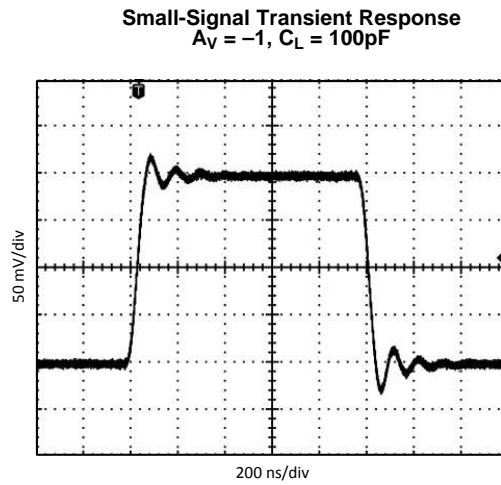

Figure 78.

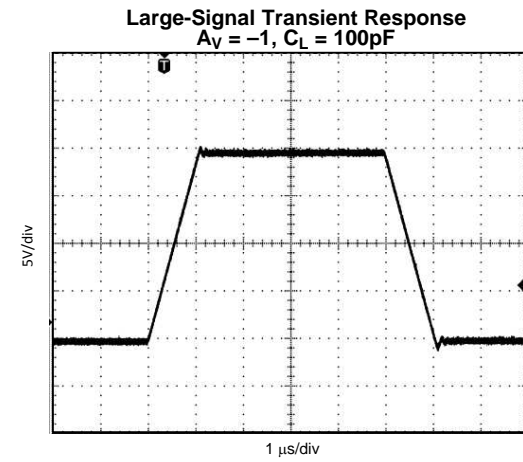
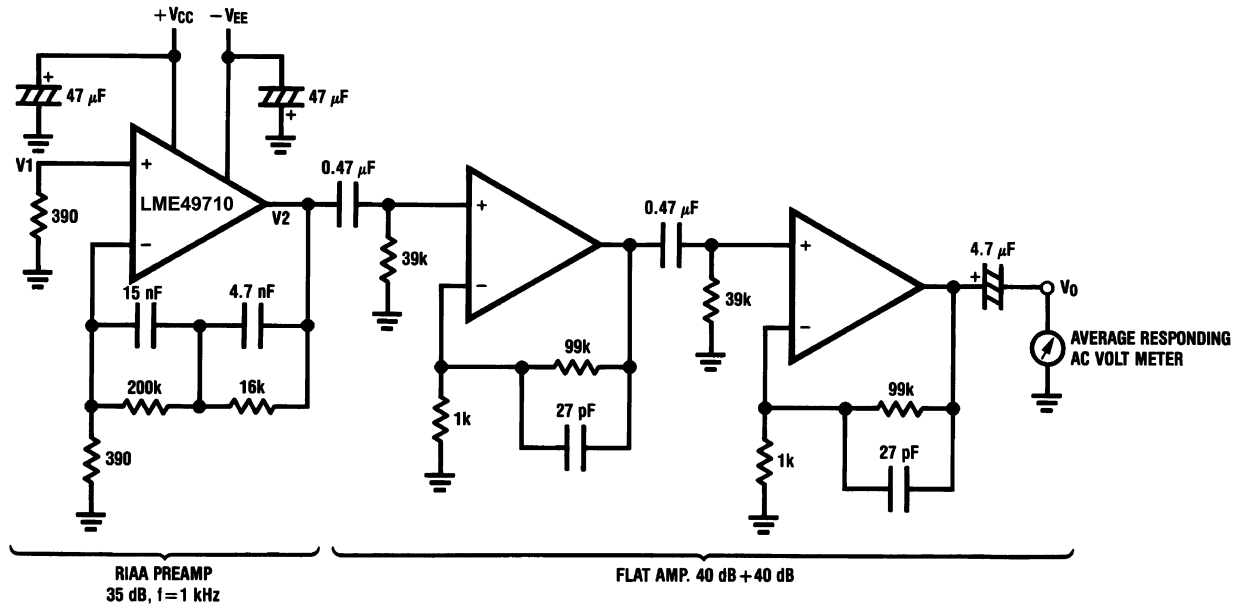

Figure 79.

NOISE MEASUREMENT CIRCUIT



- A. Complete shielding is required to prevent induced pick up from external sources. Always check with oscilloscope for power line noise.

Figure 80. Total Gain: 115 dB at f = 1 kHz
 Input Referred Noise Voltage: $e_n = V_o / 560,000$ (V)

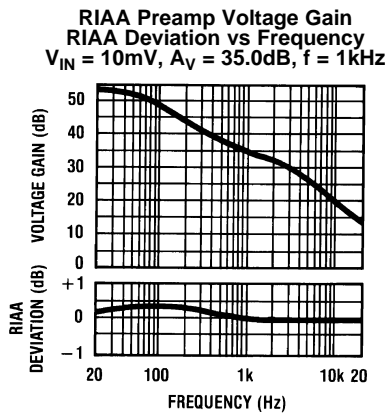

Figure 81.

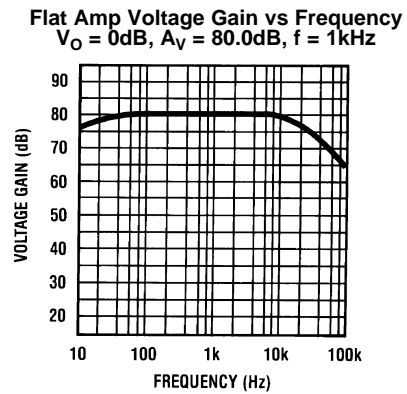

Figure 82.

APPLICATION HINTS

The LME49710 is a high-speed op amp with excellent phase margin and stability. Capacitive loads up to 100pF will cause little change in the phase characteristics of the amplifiers and are therefore allowable.

Capacitive loads greater than 100pF must be isolated from the output. The most straight forward way to do this is to put a resistor in series with the output. This resistor will also prevent excess power dissipation if the output is accidentally shorted.

TYPICAL APPLICATIONS

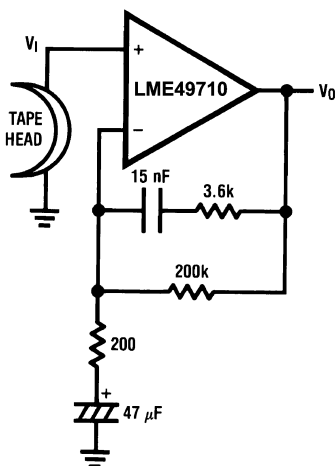

$A_V = 34.5$
 $F = 1 \text{ kHz}$
 $E_n = 0.38 \mu\text{V}$
 A Weighted

Figure 83. NAB Preamp

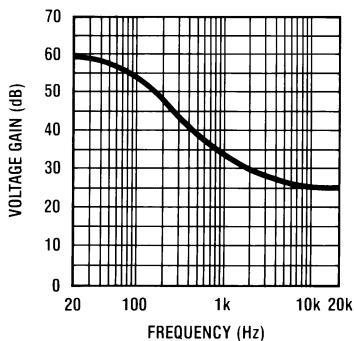
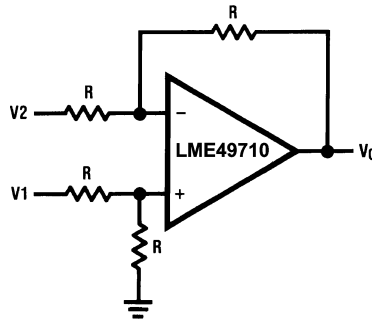
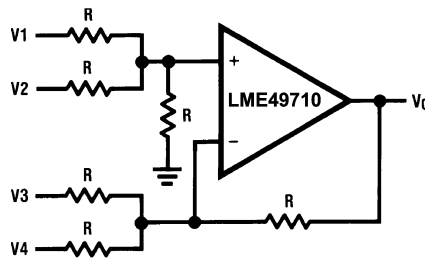

Figure 84. NAB Preamp Voltage Gain vs Frequency
 $V_{IN} = 10\text{mV}$, 34.5dB , $f = 1\text{kHz}$



$$V_O = V_1 - V_2$$

Figure 85. Balanced to Single Ended Converter



$$V_O = V_1 + V_2 - V_3 - V_4$$

Figure 86. Adder/Subtractor

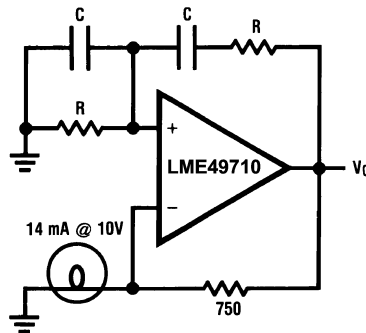

$$f_o = \frac{1}{2\pi RC}$$

Figure 87. Sine Wave Oscillator

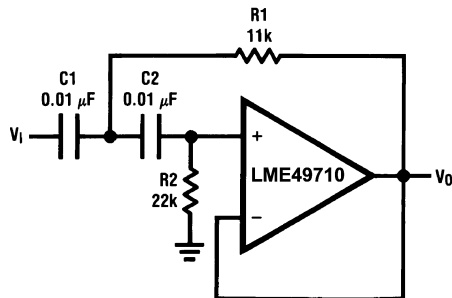

if $C_1 = C_2 = C$

$$R_1 = \frac{\sqrt{2}}{2\omega_0 C}$$

$$R_2 = 2 \cdot R_1$$

Illustration is $f_0 = 1 \text{ kHz}$

Figure 88. Second-Order High-Pass Filter (Butterworth)

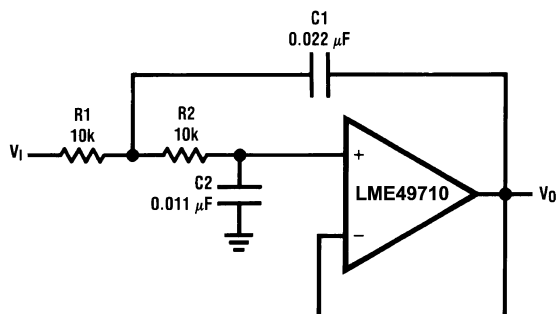

if $R_1 = R_2 = R$

$$C_1 = \frac{\sqrt{2}}{\omega_0 R}$$

$$C_2 = \frac{C_1}{2}$$

Illustration is $f_0 = 1 \text{ kHz}$

Figure 89. Second-Order Low-Pass Filter (Butterworth)

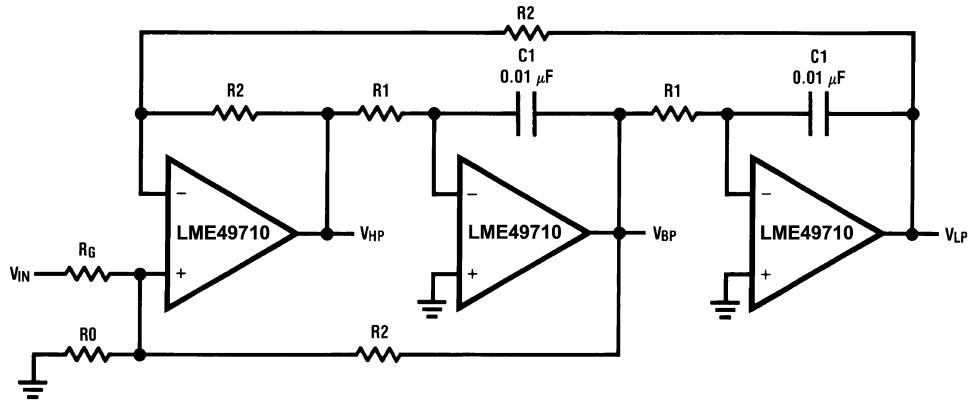

$$f_0 = \frac{1}{2\pi C1 R1}, Q = \frac{1}{2} \left(1 + \frac{R2}{R0} + \frac{R2}{RG} \right), A_{BP} = Q A_{LP} = Q A_{LH} = \frac{R2}{RG}$$

Figure 90. State Variable Filter

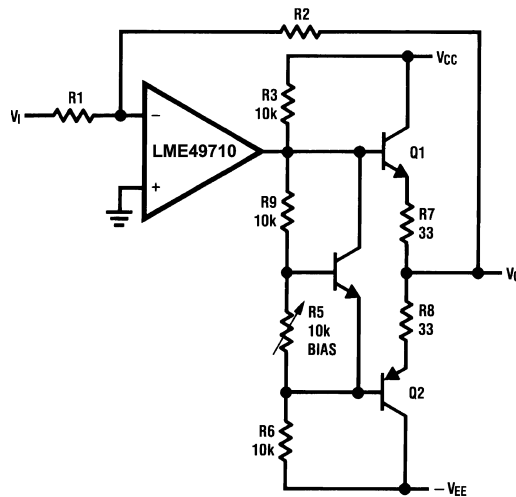
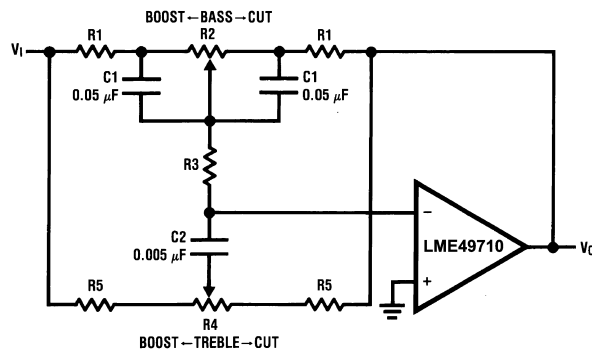

Figure 91. Line Driver



$$f_L = \frac{1}{2\pi R2 C1}, f_{LB} = \frac{1}{2\pi R1 C1}$$

$$f_H = \frac{1}{2\pi R5 C2}, f_{HB} = \frac{1}{2\pi (R1 + R5 + 2R3) C2}$$

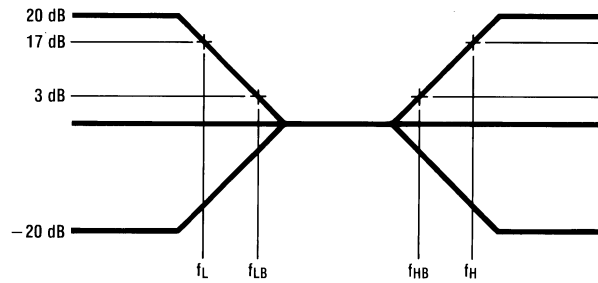
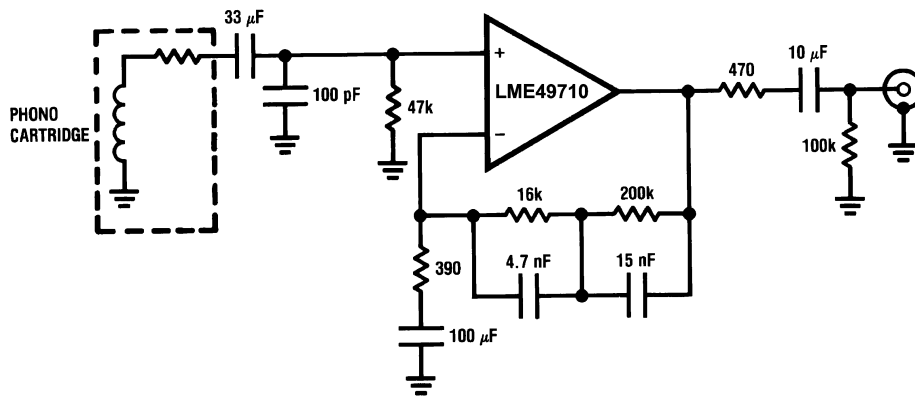
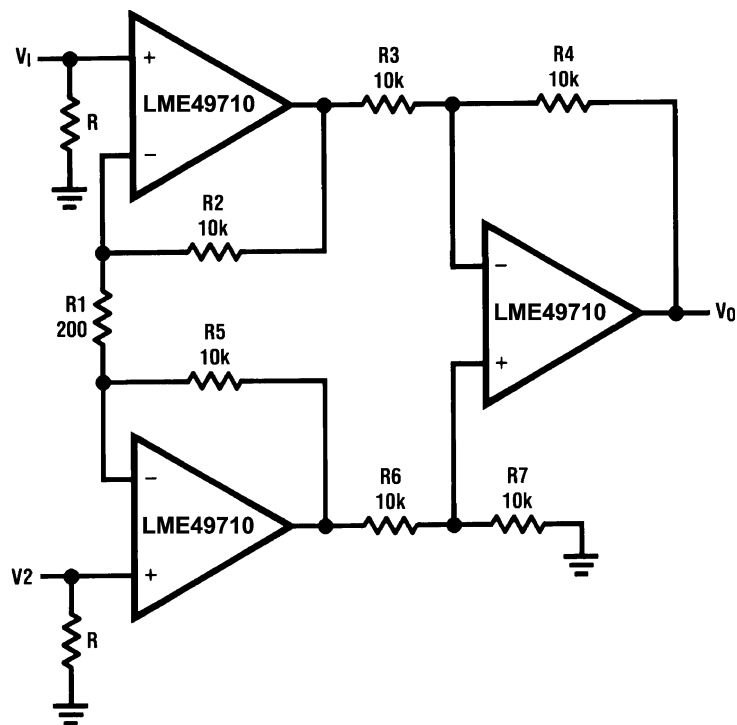

Figure 92. Tone Control



$A_v = 35 \text{ dB}$
 $E_n = 0.33 \mu\text{V}$
 $S/N = 90 \text{ dB}$
 $f = 1 \text{ kHz}$
 A Weighted
 A Weighted, $V_{IN} = 10 \text{ mV}$
 @ $f = 1 \text{ kHz}$

Figure 93. RIAA Preamp



If $R_2 = R_5$, $R_3 = R_6$, $R_4 = R_7$

$$V_0 = \left(1 + \frac{2R_2}{R_1}\right) \frac{R_4}{R_3} (V_2 - V_1)$$

Illustration is:

$$V_0 = 101(V_2 - V_1)$$

Figure 94. Balanced Input Mic Amp

APPLICATION INFORMATION

DISTORTION MEASUREMENTS

The vanishingly low-residual distortion produced by LME49710 is below the capabilities of all commercially available equipment. This makes distortion measurements just slightly more difficult than simply connecting a distortion meter to the amplifier's inputs and outputs. The solution, however, is quite simple: an additional resistor. Adding this resistor extends the resolution of the distortion measurement equipment.

The LME49710's low-residual distortion is an input referred internal error. As shown in Figure 95, adding the 10Ω resistor connected between the amplifier's inverting and non-inverting inputs changes the amplifier's noise gain. The result is that the error signal (distortion) is amplified by a factor of 101. Although the amplifier's closed-loop gain is unaltered, the feedback available to correct distortion errors is reduced by 101, which means that measurement resolution increases by 101. To ensure minimum effects on distortion measurements, keep the value of R1 low as shown in Figure 95.

This technique is verified by duplicating the measurements with high closed-loop gain and/or making the measurements at high frequencies. Doing so produces distortion components that are within the measurement equipment's capabilities. This datasheet's THD+N and IMD values were generated using the above described circuit connected to an Audio Precision System Two Cascade.

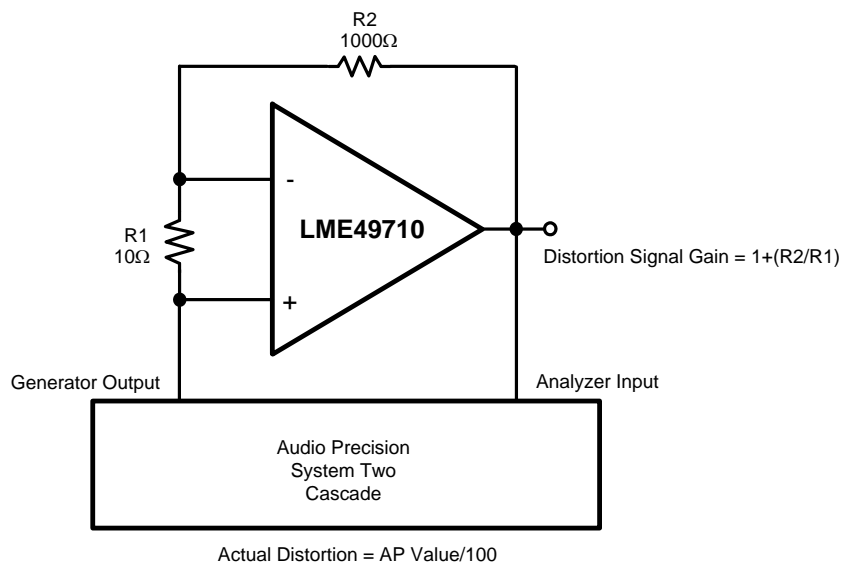

Figure 95. THD+N and IMD Distortion Test Circuit

REVISION HISTORY

Rev	Date	Description
1.0	11/16/07	Initial release.
1.1	12/12/06	Added the Typical Performance curves.
1.2	01/15/07	Added more curves and input some text edits.
1.3	03/09/07	Fixed graphics 20210489 and 90.
C	04/04/13	Changed layout of National Data Sheet to TI format.

PACKAGING INFORMATION

Orderable Device	Status (1)	Package Type	Package Drawing	Pins	Package Qty	Eco Plan (2)	Lead/Ball Finish (6)	MSL Peak Temp (3)	Op Temp (°C)	Device Marking (4/5)	Samples
LME49710HA/NOPB	ACTIVE	TO-99	LMC	8	20	Green (RoHS & no Sb/Br)	POST-PLATE	Level-1-NA-UNLIM	-40 to 85		Samples
LME49710MA/NOPB	LIFEBUY	SOIC	D	8	95	Green (RoHS & no Sb/Br)	CU SN	Level-1-260C-UNLIM	-40 to 85	L49710 MA	
LME49710MAX/NOPB	ACTIVE	SOIC	D	8	2500	Green (RoHS & no Sb/Br)	CU SN	Level-1-260C-UNLIM	-40 to 85	L49710 MA	Samples
LME49710NA/NOPB	ACTIVE	PDIP	P	8	40	Green (RoHS & no Sb/Br)	CU SN	Level-1-NA-UNLIM	-40 to 85	LME 49710NA	Samples

(1) The marketing status values are defined as follows:

ACTIVE: Product device recommended for new designs.

LIFEBUY: TI has announced that the device will be discontinued, and a lifetime-buy period is in effect.

NRND: Not recommended for new designs. Device is in production to support existing customers, but TI does not recommend using this part in a new design.

PREVIEW: Device has been announced but is not in production. Samples may or may not be available.

OBSELETE: TI has discontinued the production of the device.

(2) Eco Plan - The planned eco-friendly classification: Pb-Free (RoHS), Pb-Free (RoHS Exempt), or Green (RoHS & no Sb/Br) - please check <http://www.ti.com/productcontent> for the latest availability information and additional product content details.

TBD: The Pb-Free/Green conversion plan has not been defined.

Pb-Free (RoHS): TI's terms "Lead-Free" or "Pb-Free" mean semiconductor products that are compatible with the current RoHS requirements for all 6 substances, including the requirement that lead not exceed 0.1% by weight in homogeneous materials. Where designed to be soldered at high temperatures, TI Pb-Free products are suitable for use in specified lead-free processes.

Pb-Free (RoHS Exempt): This component has a RoHS exemption for either 1) lead-based flip-chip solder bumps used between the die and package, or 2) lead-based die adhesive used between the die and leadframe. The component is otherwise considered Pb-Free (RoHS compatible) as defined above.

Green (RoHS & no Sb/Br): TI defines "Green" to mean Pb-Free (RoHS compatible), and free of Bromine (Br) and Antimony (Sb) based flame retardants (Br or Sb do not exceed 0.1% by weight in homogeneous material)

(3) MSL, Peak Temp. - The Moisture Sensitivity Level rating according to the JEDEC industry standard classifications, and peak solder temperature.

(4) There may be additional marking, which relates to the logo, the lot trace code information, or the environmental category on the device.

(5) Multiple Device Markings will be inside parentheses. Only one Device Marking contained in parentheses and separated by a "~" will appear on a device. If a line is indented then it is a continuation of the previous line and the two combined represent the entire Device Marking for that device.

(6) Lead/Ball Finish - Orderable Devices may have multiple material finish options. Finish options are separated by a vertical ruled line. Lead/Ball Finish values may wrap to two lines if the finish value exceeds the maximum column width.

Important Information and Disclaimer:The information provided on this page represents TI's knowledge and belief as of the date that it is provided. TI bases its knowledge and belief on information provided by third parties, and makes no representation or warranty as to the accuracy of such information. Efforts are underway to better integrate information from third parties. TI has taken and continues to take reasonable steps to provide representative and accurate information but may not have conducted destructive testing or chemical analysis on incoming materials and chemicals. TI and TI suppliers consider certain information to be proprietary, and thus CAS numbers and other limited information may not be available for release.

In no event shall TI's liability arising out of such information exceed the total purchase price of the TI part(s) at issue in this document sold by TI to Customer on an annual basis.

TAPE AND REEL INFORMATION



QUADRANT ASSIGNMENTS FOR PIN 1 ORIENTATION IN TAPE



*All dimensions are nominal

Device	Package Type	Package Drawing	Pins	SPQ	Reel Diameter (mm)	Reel Width W1 (mm)	A0 (mm)	B0 (mm)	K0 (mm)	P1 (mm)	W (mm)	Pin1 Quadrant
LME49710MAX/NOPB	SOIC	D	8	2500	330.0	12.4	6.5	5.4	2.0	8.0	12.0	Q1

TAPE AND REEL BOX DIMENSIONS



*All dimensions are nominal

Device	Package Type	Package Drawing	Pins	SPQ	Length (mm)	Width (mm)	Height (mm)
LME49710MAX/NOPB	SOIC	D	8	2500	349.0	337.0	45.0

LMC (O-MBCY-W8)

METAL CYLINDRICAL PACKAGE

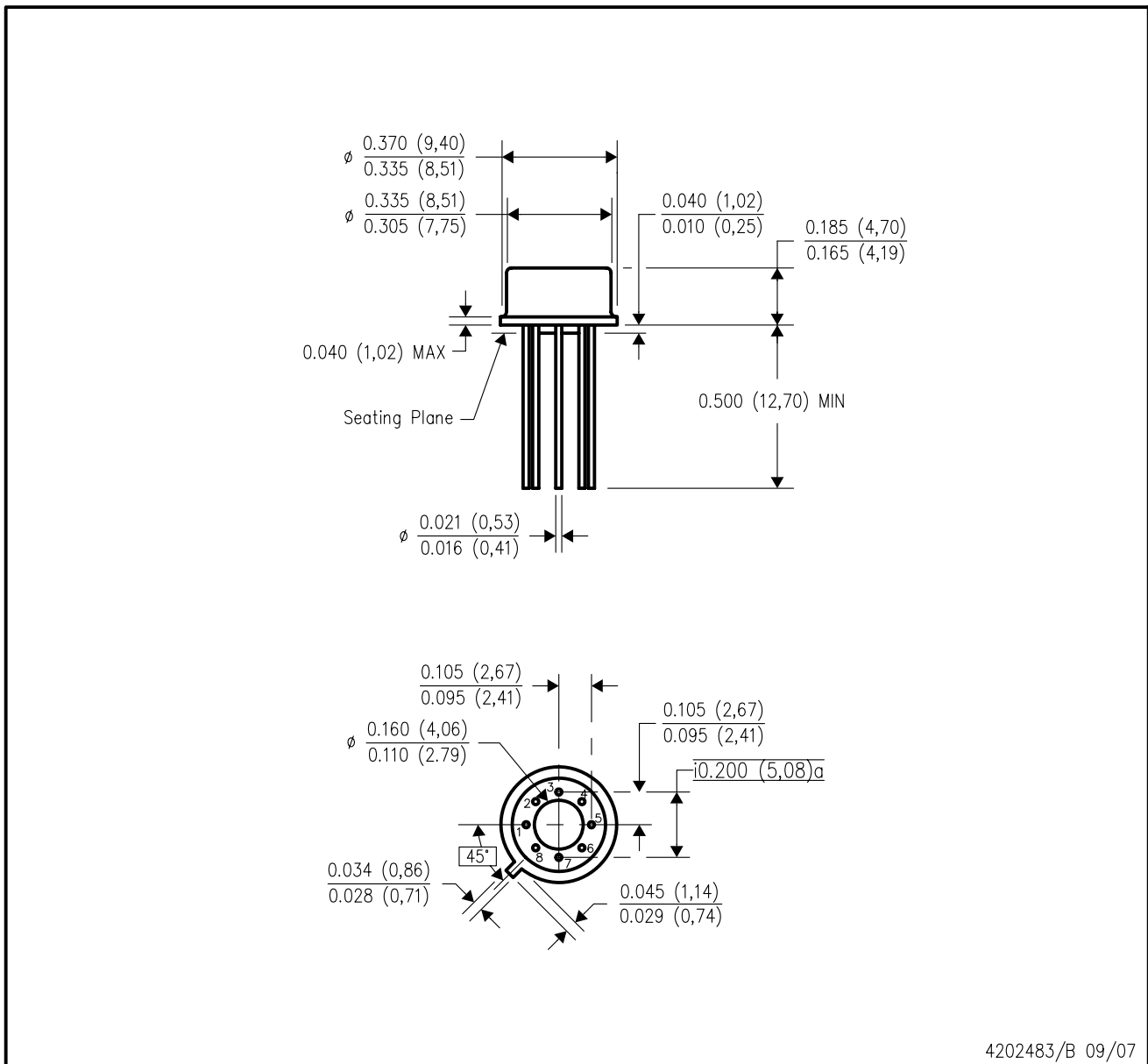

- NOTES:
- A. All linear dimensions are in inches (millimeters).
 - B. This drawing is subject to change without notice.
 - C. Leads in true position within 0.010 (0,25) R @ MMC at seating plane.
 - D. Pin numbers shown for reference only. Numbers may not be marked on package.
 - E. Falls within JEDEC MO-002/TO-99.

P (R-PDIP-T8)

PLASTIC DUAL-IN-LINE PACKAGE



- NOTES:
- A. All linear dimensions are in inches (millimeters).
 - B. This drawing is subject to change without notice.
 - C. Falls within JEDEC MS-001 variation BA.

D (R-PDSO-G8)

PLASTIC SMALL OUTLINE



NOTES: A. All linear dimensions are in inches (millimeters).
 B. This drawing is subject to change without notice.
 C. Body length does not include mold flash, protrusions, or gate burrs. Mold flash, protrusions, or gate burrs shall not exceed 0.006 (0,15) each side.
 D. Body width does not include interlead flash. Interlead flash shall not exceed 0.017 (0,43) each side.
 E. Reference JEDEC MS-012 variation AA.

IMPORTANT NOTICE

Texas Instruments Incorporated and its subsidiaries (TI) reserve the right to make corrections, enhancements, improvements and other changes to its semiconductor products and services per JESD46, latest issue, and to discontinue any product or service per JESD48, latest issue. Buyers should obtain the latest relevant information before placing orders and should verify that such information is current and complete. All semiconductor products (also referred to herein as "components") are sold subject to TI's terms and conditions of sale supplied at the time of order acknowledgment.

TI warrants performance of its components to the specifications applicable at the time of sale, in accordance with the warranty in TI's terms and conditions of sale of semiconductor products. Testing and other quality control techniques are used to the extent TI deems necessary to support this warranty. Except where mandated by applicable law, testing of all parameters of each component is not necessarily performed.

TI assumes no liability for applications assistance or the design of Buyers' products. Buyers are responsible for their products and applications using TI components. To minimize the risks associated with Buyers' products and applications, Buyers should provide adequate design and operating safeguards.

TI does not warrant or represent that any license, either express or implied, is granted under any patent right, copyright, mask work right, or other intellectual property right relating to any combination, machine, or process in which TI components or services are used. Information published by TI regarding third-party products or services does not constitute a license to use such products or services or a warranty or endorsement thereof. Use of such information may require a license from a third party under the patents or other intellectual property of the third party, or a license from TI under the patents or other intellectual property of TI.

Reproduction of significant portions of TI information in TI data books or data sheets is permissible only if reproduction is without alteration and is accompanied by all associated warranties, conditions, limitations, and notices. TI is not responsible or liable for such altered documentation. Information of third parties may be subject to additional restrictions.

Resale of TI components or services with statements different from or beyond the parameters stated by TI for that component or service voids all express and any implied warranties for the associated TI component or service and is an unfair and deceptive business practice. TI is not responsible or liable for any such statements.

Buyer acknowledges and agrees that it is solely responsible for compliance with all legal, regulatory and safety-related requirements concerning its products, and any use of TI components in its applications, notwithstanding any applications-related information or support that may be provided by TI. Buyer represents and agrees that it has all the necessary expertise to create and implement safeguards which anticipate dangerous consequences of failures, monitor failures and their consequences, lessen the likelihood of failures that might cause harm and take appropriate remedial actions. Buyer will fully indemnify TI and its representatives against any damages arising out of the use of any TI components in safety-critical applications.

In some cases, TI components may be promoted specifically to facilitate safety-related applications. With such components, TI's goal is to help enable customers to design and create their own end-product solutions that meet applicable functional safety standards and requirements. Nonetheless, such components are subject to these terms.

No TI components are authorized for use in FDA Class III (or similar life-critical medical equipment) unless authorized officers of the parties have executed a special agreement specifically governing such use.

Only those TI components which TI has specifically designated as military grade or "enhanced plastic" are designed and intended for use in military/aerospace applications or environments. Buyer acknowledges and agrees that any military or aerospace use of TI components which have **not** been so designated is solely at the Buyer's risk, and that Buyer is solely responsible for compliance with all legal and regulatory requirements in connection with such use.

TI has specifically designated certain components as meeting ISO/TS16949 requirements, mainly for automotive use. In any case of use of non-designated products, TI will not be responsible for any failure to meet ISO/TS16949.

Products

Audio	www.ti.com/audio
Amplifiers	amplifier.ti.com
Data Converters	dataconverter.ti.com
DLP® Products	www.dlp.com
DSP	dsp.ti.com
Clocks and Timers	www.ti.com/clocks
Interface	interface.ti.com
Logic	logic.ti.com
Power Mgmt	power.ti.com
Microcontrollers	microcontroller.ti.com
RFID	www.ti-rfid.com
OMAP Applications Processors	www.ti.com/omap
Wireless Connectivity	www.ti.com/wirelessconnectivity

Applications

Automotive and Transportation	www.ti.com/automotive
Communications and Telecom	www.ti.com/communications
Computers and Peripherals	www.ti.com/computers
Consumer Electronics	www.ti.com/consumer-apps
Energy and Lighting	www.ti.com/energy
Industrial	www.ti.com/industrial
Medical	www.ti.com/medical
Security	www.ti.com/security
Space, Avionics and Defense	www.ti.com/space-avionics-defense
Video and Imaging	www.ti.com/video

TI E2E Community

e2e.ti.com